

TEC Specification Sheet

Part #	I_{max} (Amps)	Q_{max} (Watts)	V_{max} (Volts)	DT_{max} (°C)	T_{max} (°C)
0090₁-9L₂3₃-12B_{x4}	12.0	7.09	1.2	67°C	200°C

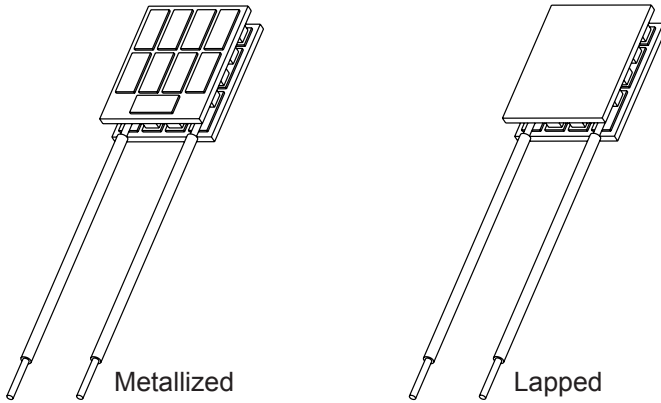

X_n Codes:

X_1 =Substrate finish codes.

0 = Metallized both top and bottom.

1 = Lapped both top and bottom.

2 = Metallized top, lapped bottom.

3 = Lapped top, metallized bottom.

X_2 =Wire type. See Wire type codes or call for custom wires.

X_3 =Height Tolerance specification. See Tolerance codes or call for custom tolerances.

X_4 =Options. See Options codes or call for custom options.

Bottom Plate				Top Plate				Metallized Height		Lapped Height	
A		B		C		D		H		H	
mm	in	mm	in	mm	in	mm	in	mm	in	mm	in
19.05	0.75	15.75	0.62	19.05	0.75	15.75	0.62	4.70	0.185	4.19	0.165

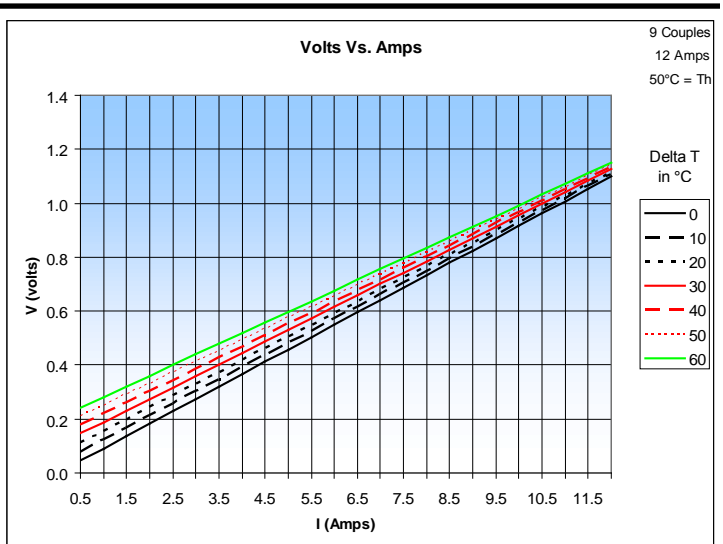
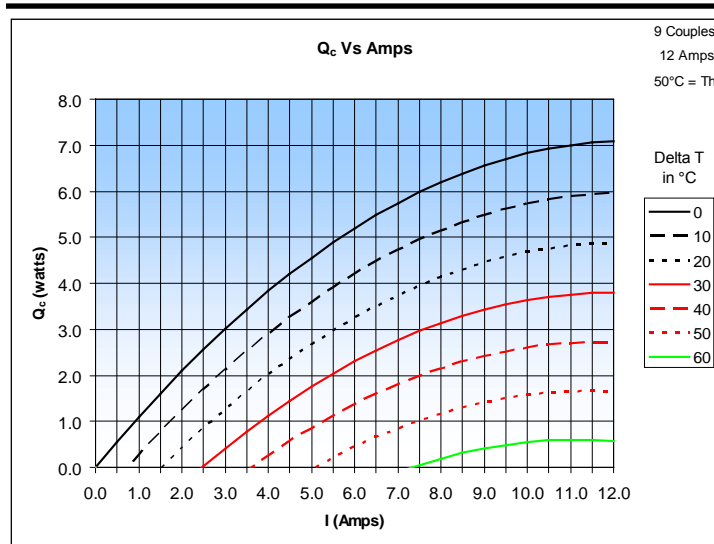
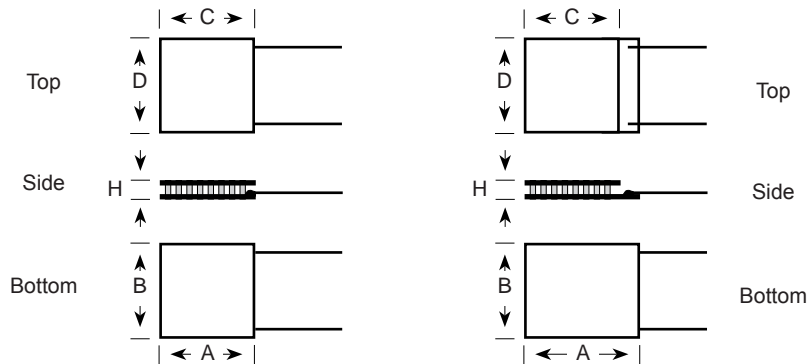

Copyright © 2006. All rights reserved. Custom Thermoelectric 11941 Industrial Park Road, STE 5, Bishopville, MD 21813

Tel. 443-926-9135 FAX: 443-926-9137 WEB: www.customthermoelectric.com E-mail: temodule@customthermoelectric.com

All technical information and data in this document is based on tests and measurements and is believed to be accurate and reliable. Product testing by the purchaser is recommended in order to confirm expected results for specific applications. Materials and specifications are subject to change without notice. REV. 9-03-2006