

TEC Specification Sheet

Part #	I _{max} (Amps)	Q _{max} (Watts)	V _{max} (Volts)	DT _{max} (°C)	T _{max} (°C)
017x₁1-9x₂x₃1-04Bx₄	4.0	4.5	2.2	67°C	200°C

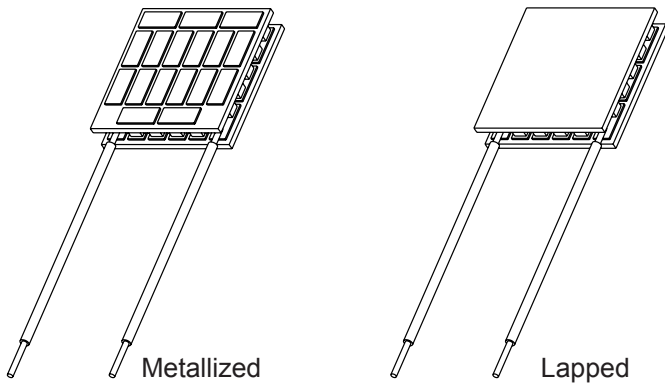

X_n Codes:

X₁=Substrate finish codes.

0 = Metallized both top and bottom.

1 = Lapped both top and bottom.

2 = Metallized top, lapped bottom.

3 = Lapped top, metallized bottom.

X₂=Wire type. See Wire type codes or call for custom wires.

X₃=Height Tolerance specification. See Tolerance codes or call for custom tolerances.

X₄=Options. See Options codes or call for custom options.

Bottom Plate				Top Plate				Metallized Height		Lapped Height	
A		B		C		D		H		H	
mm	in	mm	in	mm	in	mm	in	mm	in	mm	in
23.11	0.91	23.11	0.91	23.11	0.91	23.11	0.91	5.28	0.208	4.70	0.185

